

## RICHIEDENTE

APPLICANT / CLIENT / ANTRAGSTELLER

.....  
.....  
.....

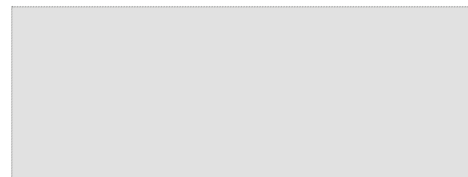

TIMBRO / CUSTOMER'S SEAL / TAMPON / STEMPEL

## MODELLO

MODEL / MODELE / MODELL

# OTTAVIO : OT-PSCF + OT-F

## ALTEZZA

HEIGHT / HAUTEUR / HÖHE

..... mm.



## NON REVERSIBILE

NON-REVERSIBLE / NON-REVERSIBLE / NICHT UMKEHRBAR

## LASTRA

GLASS / VERRE / GLAS

.....

## COLORE

COLOUR / COULEUR / FARBE

.....

## INSTALLAZIONE

INSTALLATION / TYPE D'INSTALLATION  
INSTALLATION



### A PAVIMENTO

FLOOR INSTALLATION  
SUR LE SOL  
BODENMONTIERT



### SU PIATTO DOCCIA

SHOWER TRAY INSTALLATION  
SUR RECEVEUR  
AUF DUSCHWANNE

## NOTE / NOTES / NOTES / NOTIZEN

.....  
.....  
.....

## VERSIONE DESTRA (DX)

RIGHT HANDED (DX) / VERSION DROITE (DX) / RECHTE VERSION

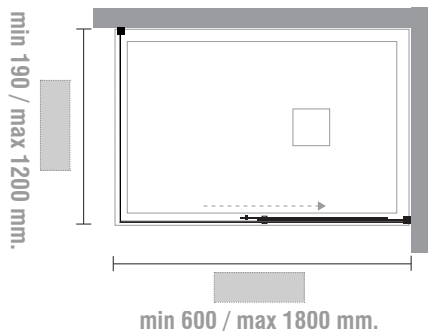

## VERSIONE SINISTRA (SX)

LEFT HANDED (SX) / VERSION GAUCHE (SX) / LINKE VERSION

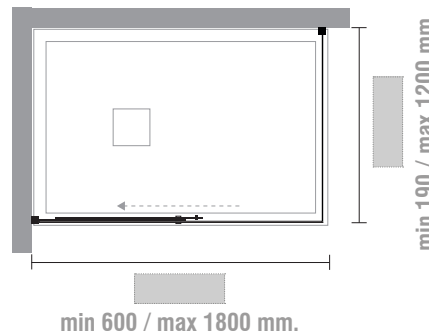

Anta / Door / Porte / Tür  
L max 794 mm.

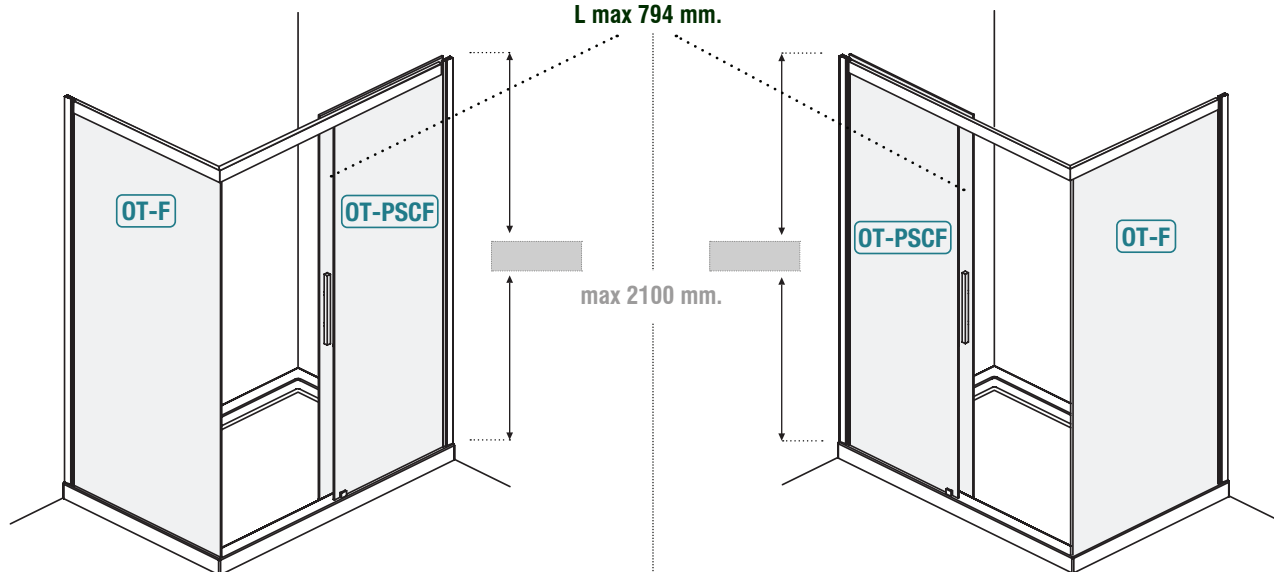

## Installazione a pavimento o su piatto doccia incassato a filo pavimento

Floor installation or on a shower tray flush with the floor

Installation au sol ou sur receveur encastré au niveau du sol

Installation auf dem boden oder auf einer bodenbündigen duschwanne

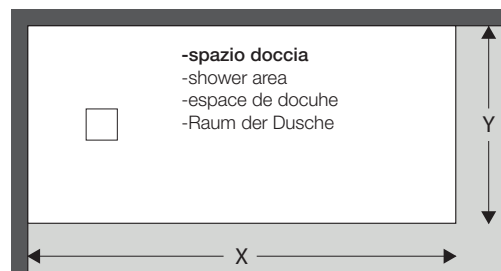

### installazione STANDARD / STANDARD installation / Installation STANDARD / Standardinstallation

la parete doccia è installata all'interno dello spazio doccia, sia su piatto doccia che a pavimento

the shower enclosure is installed within the shower space, either on a shower tray or on the floor

La paroi de douche est installée en partie intérieure de l'espace de douche, sur receveur de douche ou directement au sol

Die Duschwand wird innerhalb des Duschbereichs, auf Duschwanne oder direkt auf den Fliesen installiert

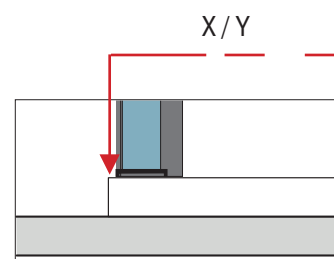
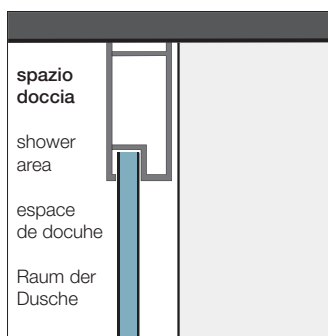
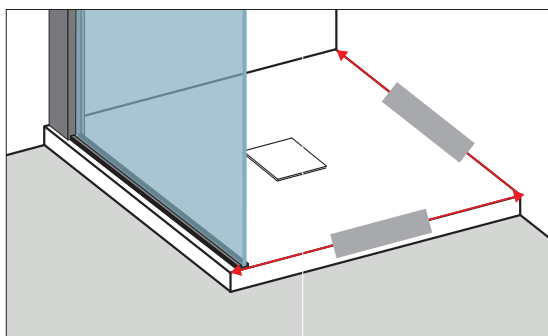

### installazione ESTERNA / EXTERNAL installation / Installation EXTÉRIEUR / Installation außerhalb des Duschbereichs

la parete doccia è installata completamente all'esterno dello spazio doccia

the shower enclosure is installed completely outside the shower space

La paroi de douche est installée complètement à l'extérieur de l'espace de douche

Die Duschwand wird außerhalb des Duschraums installiert

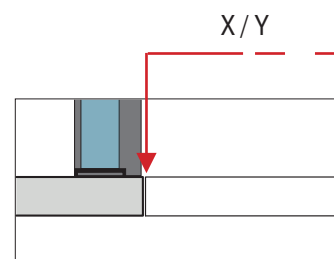
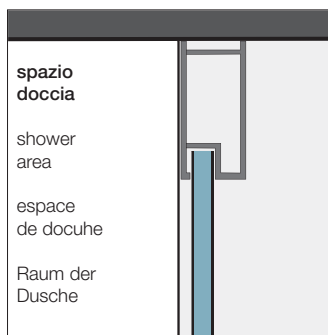
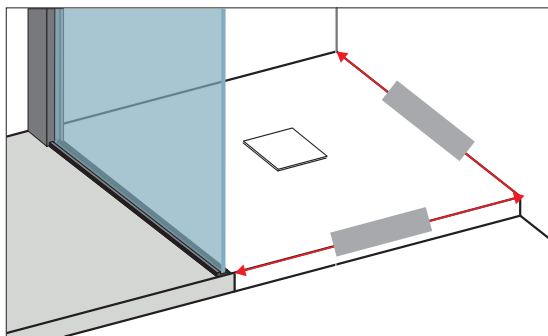

### installazione FILO PAVIMENTO / FLOOR installation / installazione FILO PAVIMENTO / FLOOR installation

la parete doccia è installata con il vetro sulla mezzzeria della fuga tra spazio doccia e pavimento

the shower enclosure is installed with the glass on the centreline of the joint between the shower space and the floor

La paroi de douche est installée à la jonction du joint entre l'espace de douche et sol extérieur

Die Duschwand wird exakt auf der Fliesenfuge installiert

